

## DYNAMIC DECKEN-EINBAULEUCHE DYNAMIC CEILING RECESSED LUMINAIRE

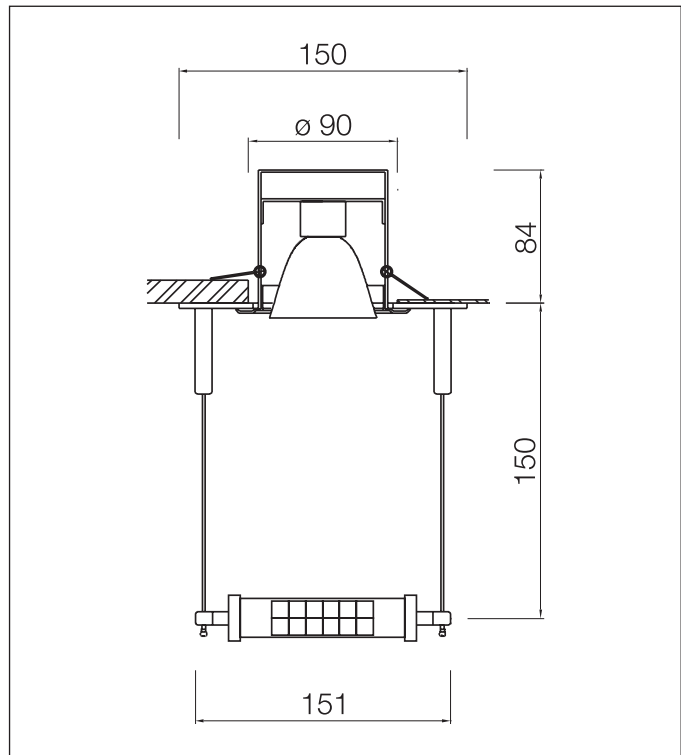
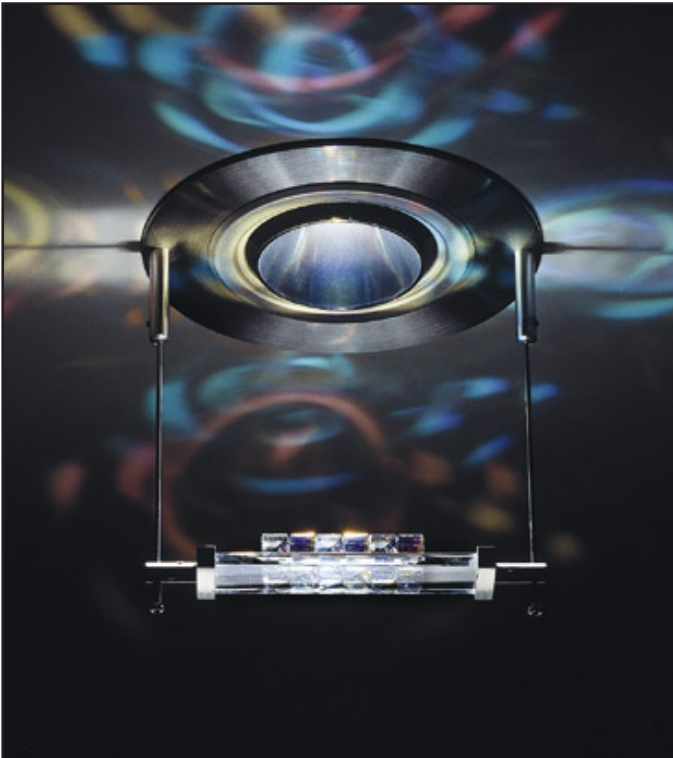

Move Leuchten sind äußerst vielseitig und flexibel: Da das Kristallelement sowohl vertikal als auch horizontal justierbar ist, lassen sich sowohl an der Decke wie auch an der Wand lebhaftere Lichtreflexionen schaffen. Die schönsten Effekte werden erreicht, wenn die Leuchten mit einem Abstand von etwa 75 cm zur Wand angebracht werden. In Ruheräumen, Korridoren und Suiten in Hotels und Privathäusern schaffen Move Leuchten eine entspannte Atmosphäre.

Empfohlenes Leuchtmittel: Swarovski empfiehlt Osram Halostar IRC, Stiftsockel GY6.35

Einbautiefe: 90 mm  
Abstrahlwinkel: 2 x 40°  
Deckenstärke: 1 - 15 mm  
Deckenausschnitt: Ø 90 mm  
Artikelgewicht: 420 g

Move luminaires are multifaceted and extremely versatile: as the crystal element is both vertically and horizontally adjustable, vibrant reflections can be cast on both wall and ceiling. The most beautiful effects are achieved when the fittings are placed about 75 cm from the wall. Move luminaires create a tranquil atmosphere in relaxation areas, corridors and suites in hotels, and in homes.

Recommended lamp: Swarovski recommends Osram Halostar IRC, pin base GY6.35

Depth of insertion: 90 mm  
Dispersion angle: 2 x 40°  
Ceiling thickness: 1 - 15 mm  
Ceiling opening: Ø 90 mm  
Product weight: 420 g





  









A 9950 NR 620 042 Titan silber / Aluminium gebürstet







A 9950 NR 620 042 titan silver / brushed aluminium

### Notizen/Notes: